

ELEVATIONS:

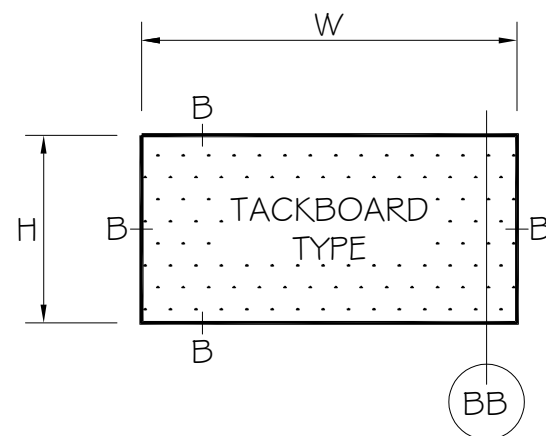

SECTION AA

MARKERBOARD
OPTION 01

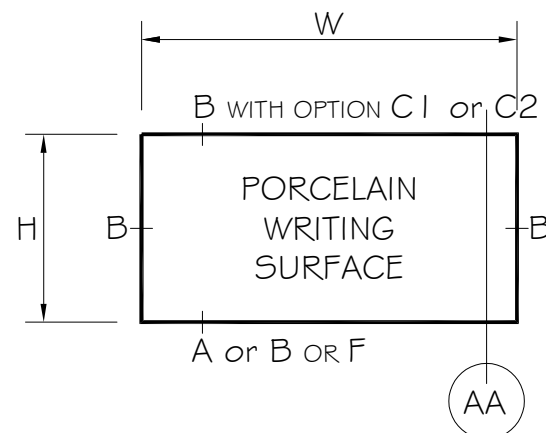
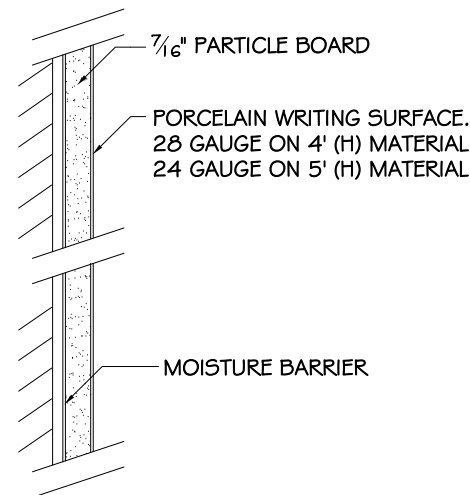

OPTIONAL COLORS:

- 29 WHITE HIGH GLOSS
- 29L WHITE LOW GLOSS
- 11 BLACK MATTE CHALKBOARD
- 06 GREEN MATTE CHALKBOARD

BOTTOM DETAIL

OPTIONAL LOWER FINISH DETAIL

REGULAR TRIM "B":

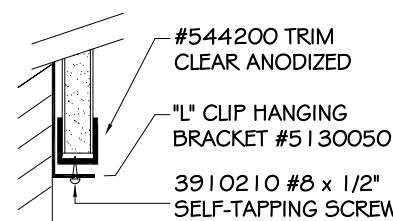

ANGLE TRAY "A" OR:

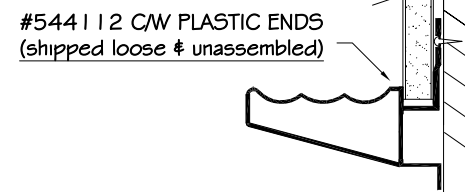

FLAT TRAY "F":

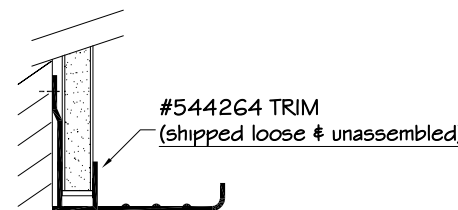

TOP DETAIL

UPPER FINISH DETAIL

REGULAR TRIM "B":

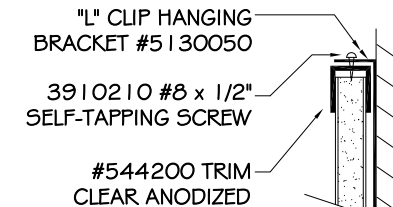

1" MAP RAIL "C1" (OPTIONAL) OR:

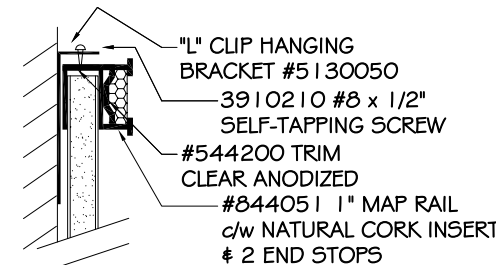

2" MAP RAIL "C2" (OPTIONAL):

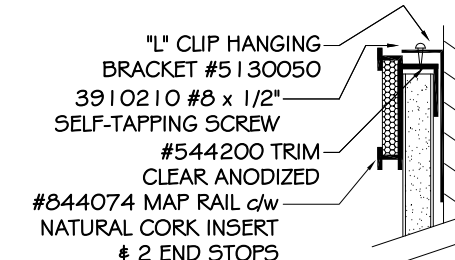

ALUMINUM TRIM:

SERIES 9800 "PRE-FRAMED"
FINISH: CLEAR ANODIZED
FACE TRIM: 3/4"

DESCRIPTION:

9800 SERIES "PRE-FRAMED"

- 01 - WHITE OR CHALKBOARDS
- 02 - FABRIC TACKBOARDS
- 03 - FORBO TACKBOARDS
- 04 - NATURAL CORK TACKBOARDS
- 05 - VINYL TACKBOARDS

OPTIONAL TRIM / MAP RAIL / TRAY:

- 01 - 4 SIDED TRIM
- 04 - 3 SIDED TRIM W/ 1" MAP RAIL + ANGLE TRAY
- 05 - 3 SIDED TRIM W/ 1" MAP RAIL + FLAT TRAY
- 10 - 3 SIDED TRIM W/ 2" MAP RAIL + ANGLE TRAY
- 11 - 3 SIDED TRIM W/ 2" MAP RAIL + FLAT TRAY
- 13 - 3 SIDED TRIM WITH ANGLE TRAY
- 14 - 3 SIDED TRIM WITH FLAT TRAY

SECTION BB

FABRIC TACKBOARD
OPTION 02

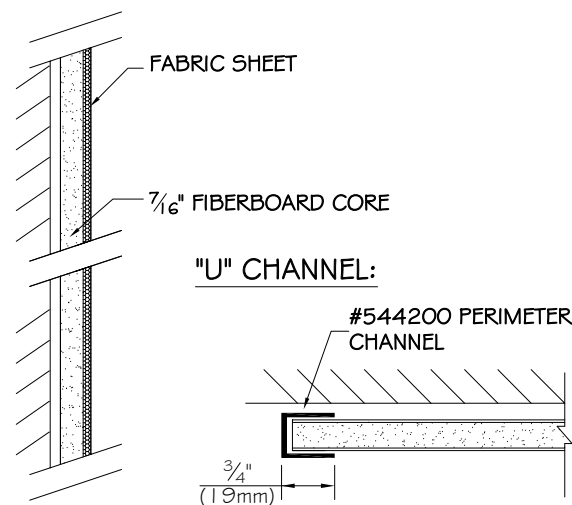

FABRIC COLORS:

- 5820 WHITE
- 5821 GOOSE
- 5822 STONE
- 5823 CAMEL
- 5824 WILLOW
- 5825 SILVER
- 5826 WOLF
- 5829 OLIVE
- 5832 BLUESTONE
- 5833 CHARCOAL
- 5834 APPLE
- 5836 BLACK
- 5837 PUMPKIN
- 5838 RED
- 5839 FOSSIL
- 5840 BURGUNDY
- 5841 NAVY
- 5842 GRAPHITE

SECTION BB

FORBO TACKBOARD
OPTION 03

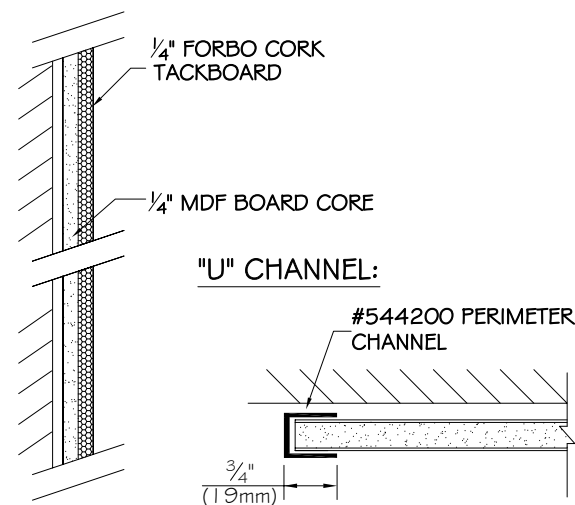

FORBO COLORS:

- 2162 DUCK EGG
- 2166 NUTMEG SPICE
- 2182 POTATO SKIN
- 2186 BLANCHED ALMOND
- 2187 BROWN RICE
- 2204 POPPY SEED
- 2206 OYSTER SHELL
- 2207 CINNAMON BARK
- 2208 MUSHROOM MEDLEY
- 2209 BLACK OLIVE
- 2210 HOT SALSA
- 2211 TANGERINE ZEST
- 2212 FRESH PINEAPPLE
- 2213 BABY LETTUCE
- 2214 BLUE BERRY

SECTION BB

NATURAL CORK TACKBOARD
OPTION 04

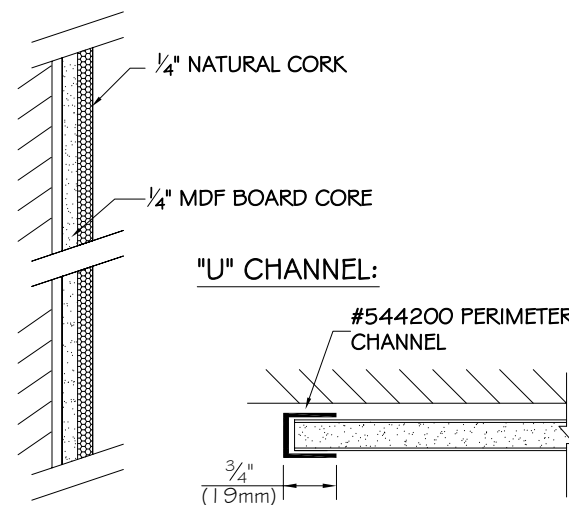

NATURAL CORK:

- FINE GRAIN NATURAL CORK

SECTION BB

VINYL TACKBOARD
OPTION 05

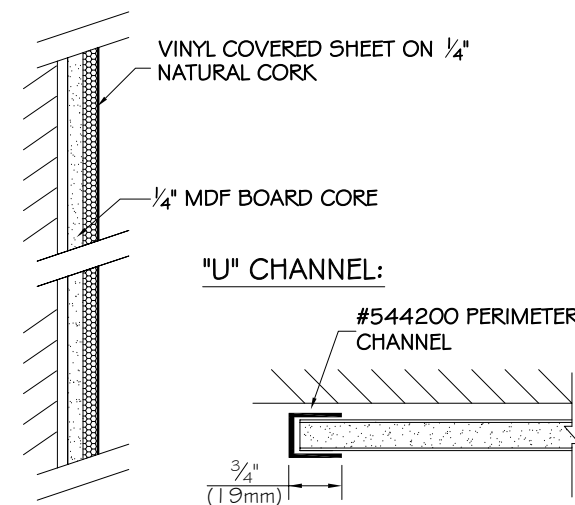

VINYL COLORS:

- 5921-54 EMBASSY CHARCOAL
- 5921-64 WHITE IRISH
- 5921-69 EMBASSY TAUPE
- 5921-98 SALEM GREY

PRODUCT CODE:

98	0X	XX	YXX	XXX
SERIES	BOARD	TRIM	SIZE	COLOUR

MOUNTING METHOD OPTION:

- "Z" TRACK #544515
- "L" CLIP HANGING BRACKET #5130050

NOTES AND/OR APPROVAL



2210 Dunwin Drive Mississauga, Ontario L5L 1C7
Phone: (905) 822-4287
www.asi-visualdisplayproducts.com

F:\ACADR\4\FILENAME PAGE NO.
TDS SERIES 9800 PRE-FRAMED 1 OF 1

DRAWN BY: DATE:
U. HERNANDEZ 16 JANUARY 2024