

ELEVATIONS:

SQUARE CORNERS

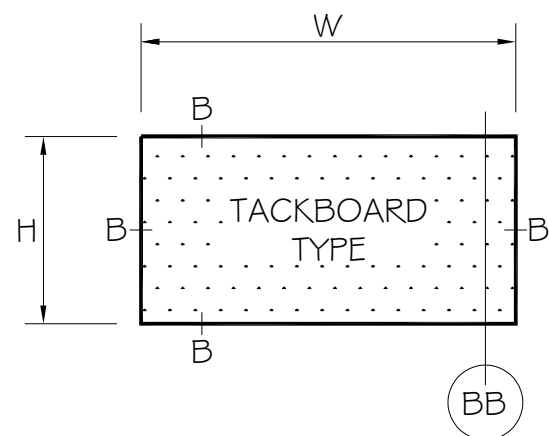
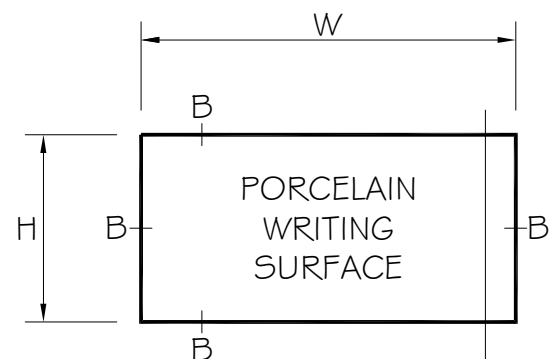

SECTION AA

MARKERBOARD
OPTION 01

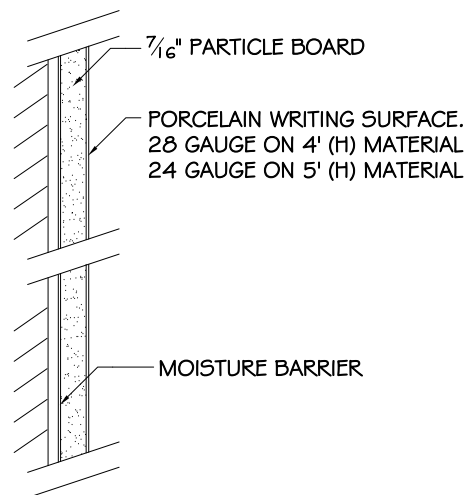

OPTIONAL COLORS:

- 29 WHITE HIGH GLOSS
- 29L WHITE LOW GLOSS

TOP & BOTTOM TRIM DETAIL

REGULAR TRIM "B":

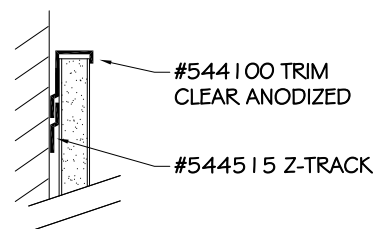

REGULAR TRIM "B":

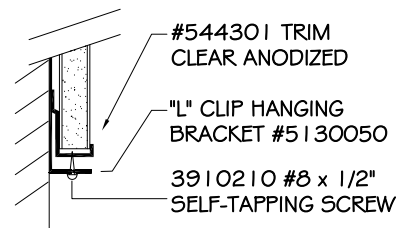

CORNER DETAIL

SQUARE CORNER

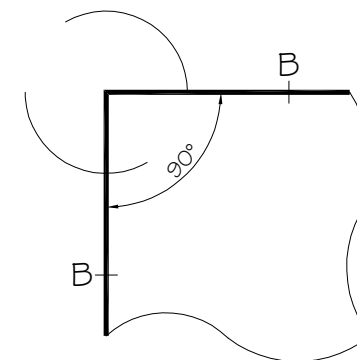

ALUMINUM TRIM:

SERIES 9100 "SLIM TRIM"
FINISH: CLEAR ANODIZED
FACE TRIM: 1/4"

DESCRIPTION:

9100 SERIES "PRE-FRAMED" - SQUARE CORNERS

- 01 - WHITEBOARDS
- 02 - FABRIC TACKBOARDS
- 03 - FORBO TACKBOARDS
- 04 - NATURAL CORK TACKBOARDS
- 05 - VINYL TACKBOARDS

SECTION BB

FABRIC TACKBOARD
OPTION 02

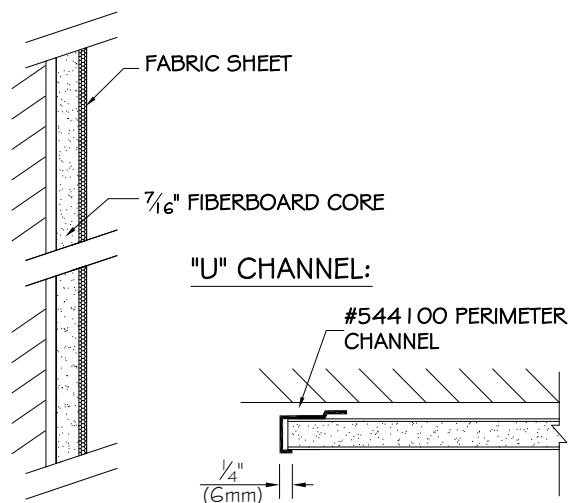

FABRIC COLORS:

- 5822 EGGSHELL
- 5823 EARTH
- 5832 WEDGEWOOD
- 5833 MEDIUM GRAY
- 5836 BLACK
- 5841 COBALT
- 5842 FLANNEL

ADDITIONAL FABRIC COLORS AVAILABLE UPON REQUEST

SECTION BB

FORBO TACKBOARD
OPTION 03

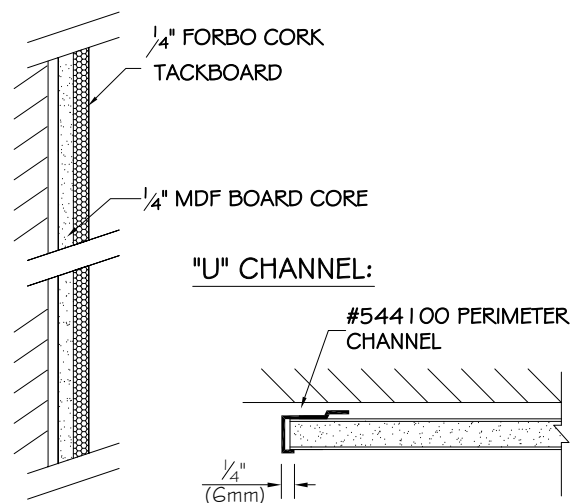

FORBO COLORS:

- 2162 DUCK EGG
- 2166 NUTMEG SPICE
- 2182 POTATO SKIN
- 2204 POPPY SEED
- 2206 OYSTER SHELL
- 2209 BLACK OLIVE

ADDITIONAL FORBO COLORS AVAILABLE UPON REQUEST

SECTION BB

NATURAL CORK TACKBOARD
OPTION 04

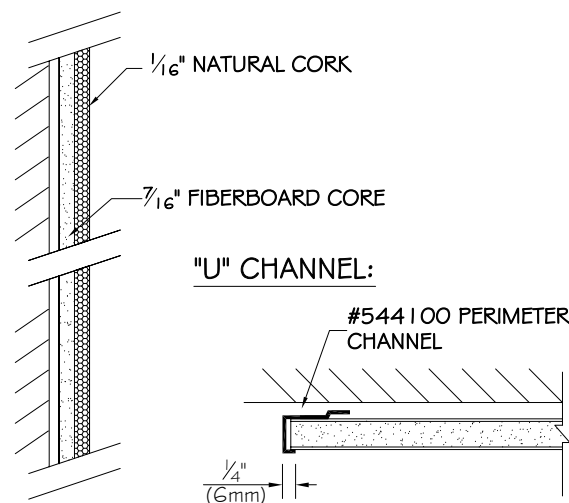

NATURAL CORK:

- FINE GRAIN NATURAL CORK

SECTION BB

VINYL TACKBOARD
OPTION 05

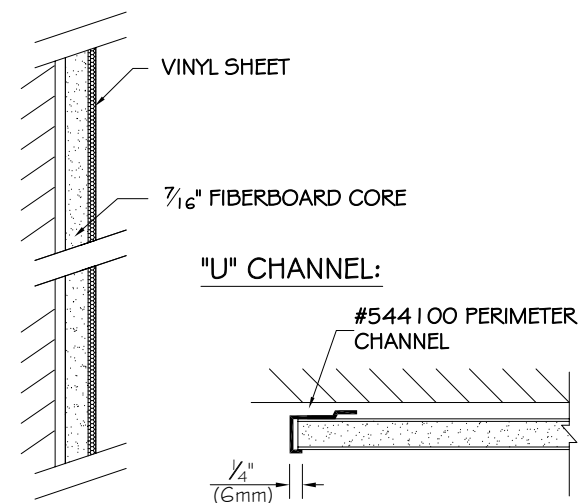

VINYL COLORS:

- 12 RICE
- 13 METAL
- 14 PEBBLE
- 15 COCONUT
- 16 ROYAL
- 19 FLANNEL
- 21 EGGSHELL

PRODUCT CODE:

91	0X	XX	YXX	XXX
SERIES	BOARD	TRIM	SIZE	COLOUR

MOUNTING METHOD:

- "Z" TRACK #544515
- "L" CLIP HANGING BRACKET #5130050

NOTES AND/OR APPROVAL



2301 East High Ave New Philadelphia, OH 44663
Phone: (330) 308 8667
www.asi-visualdisplayproducts.com

F:\ACADR\4\FILENAME
TDS SERIES 9100 PRE-FRAMED

PAGE NO.
1 OF 1

DRAWN BY:
J. UGARTE

DATE:
15 NOVEMBER 2024